

Parallel Kit Installation Guide

1. Package Inside

In parallel kit, you will find the following items in the package:

- Parallel board
- Parallel cable
- OP relay board
- Share current cable
- 2-pin red/black cable, 4-pin brown cable and 14-pin grey cable
- Blue wire and brown wire
- Long screw and short screw for assembly

Note: The specs of relay board, wire, and cable are different for 6K(L) and 10K(L) model. Please DO NOT install 6K(L) parallel kit to 10K(L) model.

2. Product Introduction

By installing parallel kit into standard models, the standard online UPS can be operated as parallel system. This kit simplifies the process of upgrading standard model to parallel model and provides high flexibility to customers.

3. Installation

The installation will apply to 6K(L)/10K(L) models

Step 1: Remove U cover by unscrewing all screws.



Step 2: Remove covers of share current port and parallel port by unscrewing 3 screws.

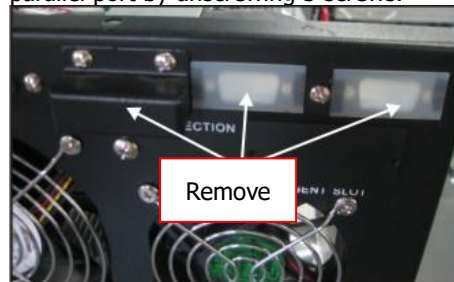

Step 3: remove two wires on the PSDR board. (The two wires be connected to OP Relay board later)

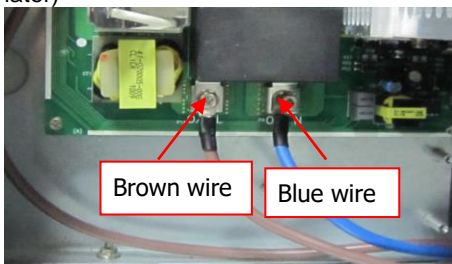

Step 4: Install the OP Relay board.

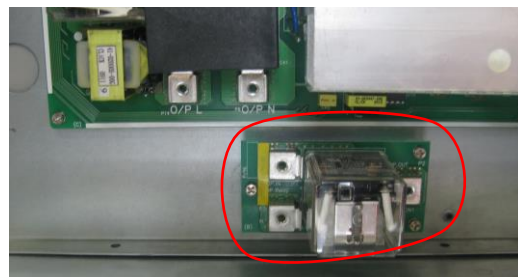

Step 5: Connect the OP Relay board to the PSDR board with two short wires, and make the brown wire that removed in step 3 cross the yellow core 5 turns, connect the brown and blue wire to the OP Relay board refer to the following picture, connect the 4 pins brown cable from OP Relay board to PSDR board.

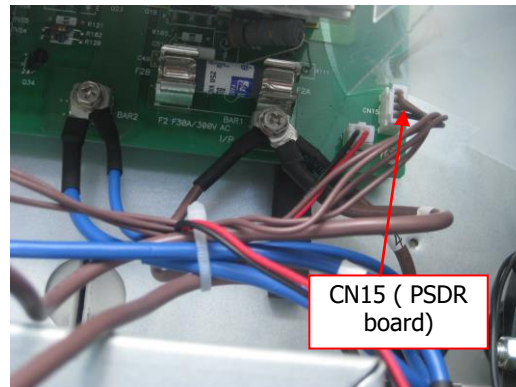
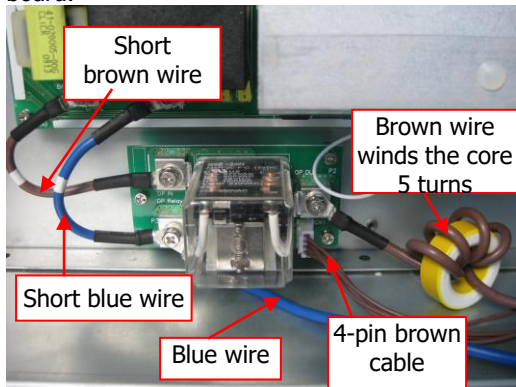

Step 6: Install and screw parallel board tightly. Then use long screw to fix female side of parallel port and short screw to fix male side of parallel port.

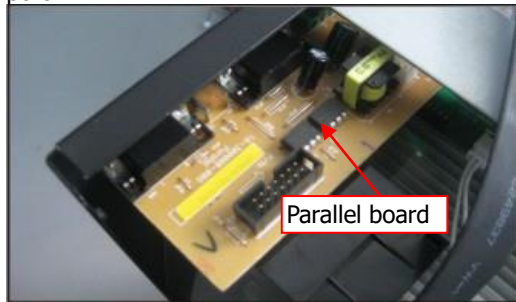

Step 7: Use 14-pin signal cable to connect CN11 of control board and CN1 point of parallel board. Use 2-pin power cable to connect CN10 of commu board and CN9 of parallel board.

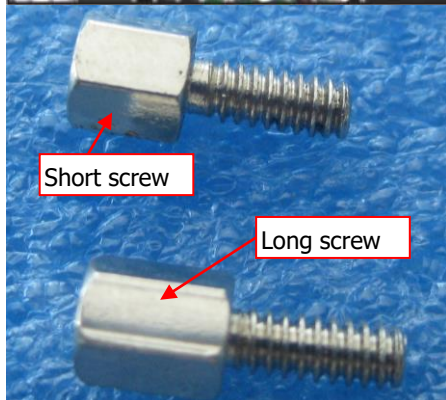
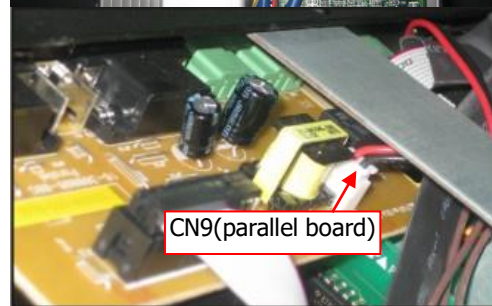
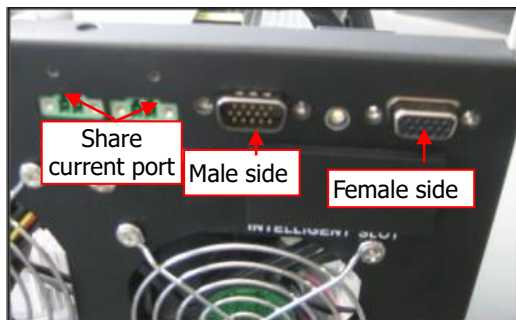
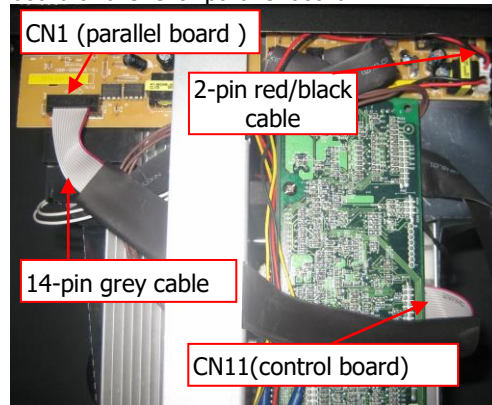

Step 8: Put U cover back to the unit. Now the UPS is providing parallel operation function.

4. Wiring Connection for Parallel Operation

Please follow below steps to connect cables for 6K(L)/10(L) parallel models. It will provide high flexibility for future maintenance and upgrades.

Requirements: Two parallel cables and two share current cables.

Step 1: Please follow below figure to connect parallel cable and share current cable. It's all dummy-proof design which can prevent customers from mis-connection. However, any stress to cables will cause bad contact or broken inner wires. Please be aware of that.

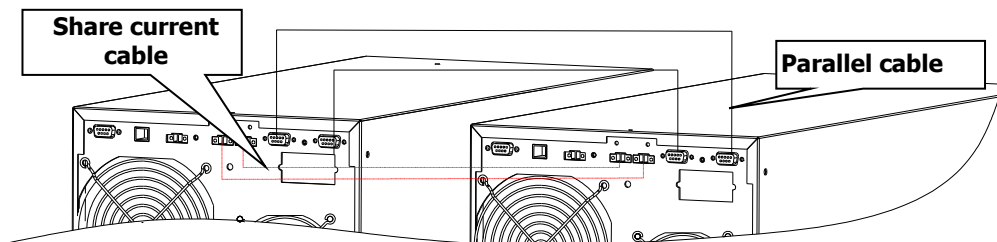
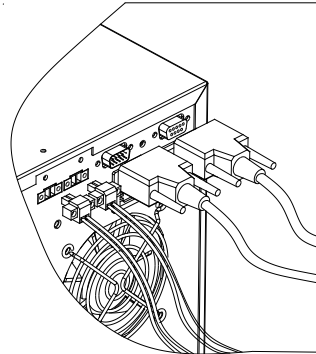

Step 2: Input and output grounding wires are directly connected to the case. Refer to below chart for the input/output terminal wire connection.

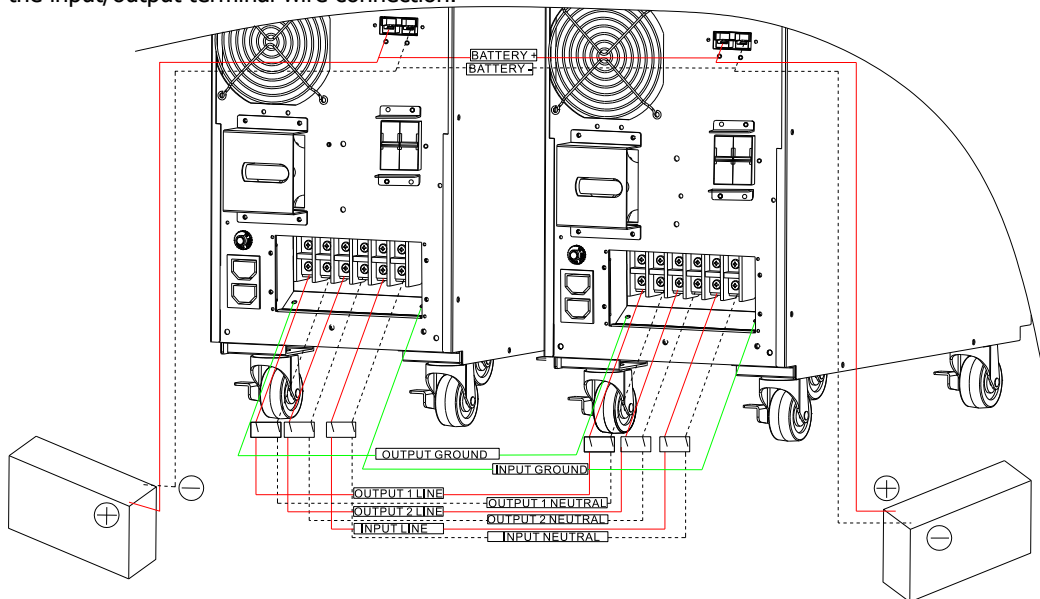

If the UPS is connected to external battery pack, it's required to install battery breaker (DC type) in each UPS. Besides, we strongly suggest to install a breaker (AC type, D curve) for input/output in each unit. Please refer to UPS user manual for the selection of diameter and color of the wires.

PS. Each UPS connects to different battery sets.

Appendix 1: Wiring Connection for Two UPSs running in parallel

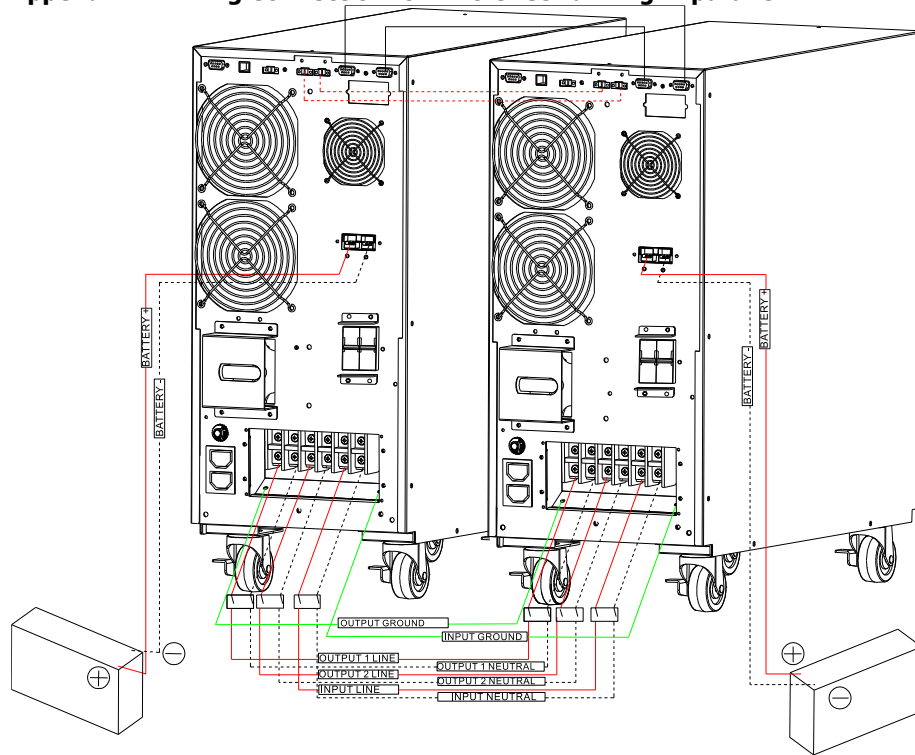

Appendix 2: Wiring connection for three UPSs running in parallel operation

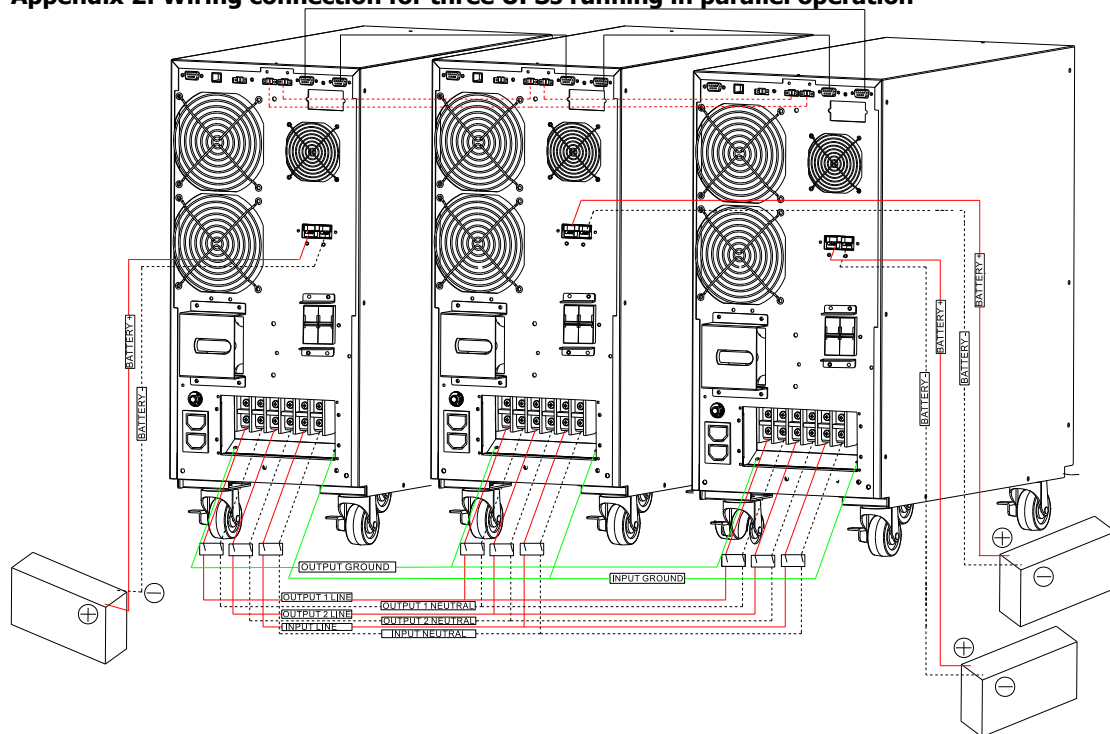

Se coloca solo en los UPO22