

Warranty

☉ To receive after service, have the following ready before you contact our branches.

1. Name of the product.
2. Model number of the product.
3. The area of problem.
4. Phone number and address at which you can be contacted.

Warranty Card

PRODUCT	
MODEL	
DATE PURCHASED	
WARRANTY PERIOD	
AGENCY ADDRESS	

☉ KOCOM Warranties the original purchaser of this product as follows.

- 1) This product is produced under strict quality control and inspection procedures.
- 2) If this product breaks down during proper use as a result of product defect, KOCOM will repair it within one year from date of purchase free of charge.
- 3) The following cases will be subject to charge, even during warranty period:
 - a. Breakdown during transport, or through careless treatment, by consumer.
 - b. Breakdown cause by unauthorized repair, or system modification.
 - c. Breakdown caused by natural disaster or power disorder.

KAM-D340 MANUAL

[Operating Installation Manual]

Guard Station Video Phone COLOR HANDSET

- Call & Communication with Residential unit
- Receive a call from Lobbyphone and Communication & Door Open
- Operating Condition displayed on the monitor (OSD)
- Easy ID / System Type / Guard Absence Settings (OSD)
- 'LINK' function to reconfirm a visitor

: Receive a call from Lobbyphone and hold the line while talking with the resident and link the call to the residential unit



KAM-D340

Cautions for safety

For safe use, please stick to the following cautions.

- Please, save this manual after reading these instructions carefully.
- Read and understand all instructions to set up rightly.
- This Cautions for Safety may include items that are not contained in specifications of the product that consumer purchases.
- If you need assistance with the set-up or operation, please contact with A/S center.

The important marks in the manual.

To help our customers to understand this manual, to prevent any personal injury or property damage, some marks are used in the manual. The marks and the drawing signs are below. Please, understand the marks before reading the manual.

The meaning of the drawing signs.

	Sign to show what not to do.		Mishandling the device with ignoring this sign may result in serious injury or death.
	Mishandling the device with ignoring this sign may result physical injury or material damage.		Mishandling the device with ignoring this sign may result physical injury or material damage.
	Sign to tell you that you should follow the instructions.		Sign to tell you that you need more attention including (high voltages, electric shock, danger, warning)
	Sign to tell you that you can't disassemble this unit.		Sign to tell you that you must unplug the unit.

Caution

Caution for set-up

- The law limits distributing the power lines to an authorized person from government. The work from an unauthorized person cause fire or electric shock.
- Place this unit securely on a stable surface. Serious damage and/or injury may result if the unit falls.
- Do not set up this unit near the leaking place because it may expose you to dangerous voltages or other risks.
- Even if your product is water proof, do not install it slanted place of water leakage, which can a short circuit.
- Fix the product on the wall safely according to the installation guideline to prevent any damage or injury.
- The work of distributing wires needs skills and experiences. So please, for assistance, contact your dealer or call service center.
- The communication lines should be built in being distant from the power source. This may result in the risk of fire, electric shock and communication disorder.
- Setting the communication lines in a high humid place such as outside without any protection from rain causes the communication disorder.
- Keep the hook at the wall-mounted device safe. The hook may cause the physical injury.
- Think about the thickness and quality of wall material. The unqualified material may make the device fall.

- Set the device of the wall-mounted type not to fall. Falling from an earthquake causes personal injury.

Caution for Repairs and Maintenance

- Keep the inside of the device clean. Having the dust inside without any cleaning for a long time causes the fire. If necessary, contact your dealer or service center to get cleaning service.
- Unplug this device when you want to check the inside. If there is no plug, please, turn off the circuit breaker.
- Unplug this device when you try to move it to another place. If the electric line is connected inside of the unit, please contact your dealer or service center.
- Do not use liquid or aerosol cleaners. Use a damp cloth for cleaning.

Warning

Warnings for Usage

- Do not install this unit near the water and dust, for example, in a bathroom or near the washing machine. It caused fire and electric shock.
- Do not install this unit near the fire, for example, near kitchen sink, heater or the like.
- Do not install near the noxious gas such as Hydrogen Sulfide, metal power and the like.
- Do not install near the water and chemicals.
- Do not give any damage, break and modify the plug. Overloading, heating, pulling causes the damage.
- Do not place the plug near the heater. The damaged code causes fire and electric shock. Do not pull the power code when unplugging.
- The damaged code causes fire and electric shock. Must pull with plug. Do not touch with wet hands. It causes the electric shock.
- Do not use any other voltage, except the marked regular voltage.
- Do not use the power terminal at the units to other electric device except the designed device.
- Do not install the units at the leaking place if it doesn't have any waterproof mark. Do not install the unit when the power is on.
- Install the circuit breaker after checking the safety such as electric shock and leakage. Turn off the power before you install or A/S
- Check the suitability of the lines for installing when you use the exiting lines.
- Do the wiring work by using the designed material.
- Connect the electric wire with the designed ways and ground.
- Do not connect with any other devices except the designed devices to compose the system.
- Unplug electric wire and communication lines from the units before moving to another place.

Caution for Use

- This unit is not designed for security purpose.
- Do not place a pot with water or a small metal material on the Units.
- Do not cover the ventilating opening or put any metal material in the units.
- During thunderstorms, avoid using this unit. There may be a remote risk of an electric shock from lightning.
- Do not modify the unit.
- Do not handle the unit with the wet hands.
- Open the main gate after checking ID if the image and sound system do not work, Call A/S

- Do not disassemble the back and cabinet cover.

Caution for Abnormality

- Change the damaged electric code.
- Unplug this unit from plug socket and refer servicing to an authorized service center when the following conditions occur:
- If liquid has been spilled into the unit.
- If the unit does not work normally by following the operating instructions.
- If the unit exhibits a distinct change in performance.
- If the unit has been dropped or physically damaged.

Caution

Safety Instructions, Warnings and Cautions of Each System

- Do not disassemble this unit as will as this device is composed by precision parts.
- Install the unit by following the set-up instructions of Kocom.
- Do not touch or insert any foreign substances, for example, sticker, magnetic, opener and the like.
- Make U-type at the end of wires as the rain can effect on the system by following the wires during the rainy season.

Videophone

- Separate the AC/DC lines with the hook of the wall-mounted type when installing.
- Do not distribute signal line with AC line.
- Do not clean the LCD with the damp cloth for cleaning. Use the only dry and soft cloth.
- Connect the lines after peeling the wires properly.
- Use the designed driver to connect the lines to terminal.
- Do not install the main gate monitor at the leaking place.

Things You Need to Know

- This product is designed as a home videophone and cannot use continuously like monitor camera.
- If there is temperature difference between inner part of camera and surrounding, dew condensation occurs on camera lens and may disturb image. If dew condensation is removed from camera lens, image quality recovers.
- White LED light examination range is narrower than camera shot range at night, so there is less amount of light at night than day. So it is difficult to see the face in low illumination condition due to noise increase on screen, but it is not from defect.
- Monitor screen (liquid crystal panel) is not in defect when some pixels always light or black out.
- Please install monitor and camera over 5cm away.
- Also, avoid installing at a place with too much noise, because too much noise around camera causes phone call inferiority.
- Do not place an object within 20cm in front of monitor. It causes phone call inferiority, especially because microphone is installed at the top of monitor.
- If strong light such as sunlight flows into camera module, screen saturation (or strange mark) and image shaking might occur.
- This is not a defect, so please do not install camera where a direct ray of light do not flow if possible.

Cautions

- In some cases there is occurrence of product destruction, malfunction, noise mixing and picture quality deterioration due to mixing of other tool's induced, voltage or thunder with communication wiring of monitor/camera, monitor/extended monitor.
- Do not wire with power line such as outdoor wiring or AC power, or phones and other tools.
- You cannot use it if you incorrectly wire the AC voltage between monitor/camera, monitor/extended monitor.
- Call the store or agency where you purchased this product and consult to solve the problem.
- Beware that unfixable damage might be caused due to authorizing AC voltage on communication wiring of monitor/camera, monitor/extended monitor.
- Do not ever disjoint this product. It may cause electrocution accident when touching high-voltage circuit inside this product.
- Outside power authorizing this product must be confirmed of product description and use rated voltage.
- Beware that if higher voltage is authorized, unfixable damage might be caused due to product destruction.
- Power must be connected to domestic voltage (product rated voltage) consent or interior wiring.
- If connected to other motive power or inverter-type power, product destruction, noise mixing, and picture distortion may occur.
- Do not drop this product. Glass is used for monitor and might break, or cause other circuit inferiority.
- In such case, immediately turn down the power switch, and call to consult agency or store in which this product was purchased.
- Keep away from any conditions where water splatters or falls. Do not place anything containing water like a vase on the product.
- If installed near transmission antenna such as broadcasting station, electric wave may mix and cause picture distortion or voice mixing.
- Avoid installing near tools with strong electromagnetic waves such as microwaves and cell phones, or it may cause picture distortion.
- Do not install monitor in following places.
 - ① Above or around water heater, rice-cooker, heater
 - ② Place exposed to direct rays of the sun
 - ③ Place with temperature below 0°C such as cold store
 - ④ Place with high humidity such as bathroom, washroom, heated room
 - ⑤ Place with a lot of gas, dust, smoke
 - ⑥ Dangerous place with sprays of water or chemicals
- Do not wipe with insecticide, drugs or chemicals such as thinner and alcohol, or it may damage the surface of this product.
- Beware of occurrence of image quality deterioration or malfunction from cause of humidity due to penetration of chemicals or water into camera's urea resins.
- As in the picture, it prevents temperature difference of camera (outside) and monitor (inside), and removes dew condensation caused by humidity of camera window.
- Camera must be installed when wall cement is completely dry.
- When product is installed in winter below -5°C, wait for approximately 2 hours to connect. Dew formation in monitor and camera due to temperature difference inside and outside may cause product defect.
- Avoid installing monitor and camera in place directly exposed to heat or where gas noxiousness is highly occurring.

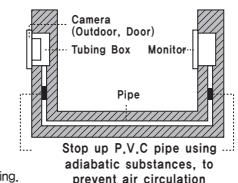

Components of product

■ Monitor

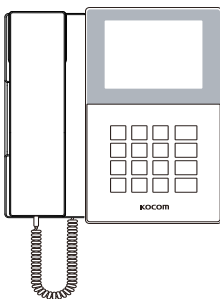

■ A Wall hanger frame

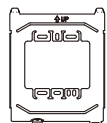

■ Wire



2.5pitch 4 pin cable 1ea



2.0pitch 4 pin cable 2ea

■ Screw for fixing monitor



4X25mm 4ea

3X8mm 1ea

■ DC 15V Adapter(DC type)

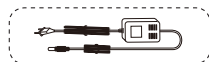

Name and Functions of each part

■ Monitor part

· Front

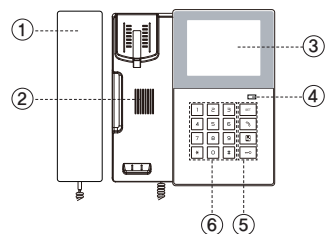

· Back

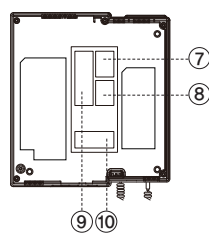

· Bottom

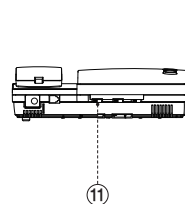

- ① Handset
 ② Speaker
 ③ Monitor Screen : 4" Color LCD
 ④ Power LED
 ⑤ SET : Setting of special function SET button.
 [] : Call a residential unit by pressing a button after dialing the number of the unit Press a button to receive an incoming call while the handset is being lifted.
 [] : LINK button to connect between the lobby and a residential unit.
 [] : Door opening during communication.

- ⑥ Dial Button
 ⑦ A connection terminal to the lobby when a guard station is placed between the lobby and a repeater.
 ⑧ A connection terminal of the repeater when a guard station is placed between the lobby and a repeater.
 ⑨ Upgrade port
 ⑩ A connection terminal to the lobby when a guard station is directly connected to the lobby.
 ⑪ Call Volume : 3-level adjust the call sound volume.

Installation location

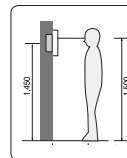

■ Monitor installation location

- Standard monitor installation height is about 1,500mm where screen center is at eye level.
- In this case, wall-hanging metal center (center of piping) is 1,450mm above ground level.
- Standard installation height

■ Monitor installation

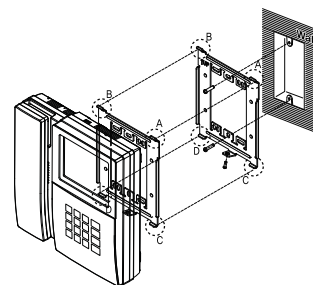

■ Directly connecting cut-off power cord with power wire

- Do not do such electric work on your own. Installing product in this way requires reliance on electric installation man with electric work license.
- Insulate with insulating tape while cutting off power cord and connecting with power wire so electric wire metal does not expose. Contact between exposed electric wires cause fire or electric shock accident.
- Such electric work requires connection after interception of supplied power.

- Remove wall-hanger bracket metal behind monitor.
- Install wall-hanger bracket metal on 1 type box or wall with attached Vis.
- Connect wiring to monitor back terminal referring to product connection diagram.
- Hang monitor on wall-hanging metal, and fix monitor on wall-hanger bracket metal using attached Vis.
- Plug monitor's power plug into consent and check to see if the power switch is [ON] on the left side of monitor.

Specifications

	Model No.	KAM-D340	
Guard Station	Power Source	DC 15V ±1V 2A	
	Power Consumption	Stand by 1.5W, Max 10W	
	Operating Temperature	0°C ~ +40°C	
	LCD	4 Inch color LCD	
	Communication System	Duplex handset conversation	
	Wiring	Repeater : 4 wire(Polarity) / Lobby : 4 wire(Polarity)	
	Mount Type	Surface mount	
	Dimension	207(W) x 215(H) x 60(D) mm	
	Compatible Units	Lobbyphone	: KLP-C420 / C420R
		Color Monitor	: (4.3") KCV-434 / D434 / 434SD / D434SD, KCV-454 / D454 (7") KCV-504 / D504
Doorphone		: KDP-602GD	

Product connection diagram

■ A type – Between Mode

When a guard station is placed and connected between the Lobbyphone (KLP-C420/C420R) and Repeater (KVS-A4P/A8P)

※ Guard number set on the Lobbyphone must be the same with Guard number set on the Guard station.
 (* Available Guard number : 00~09)

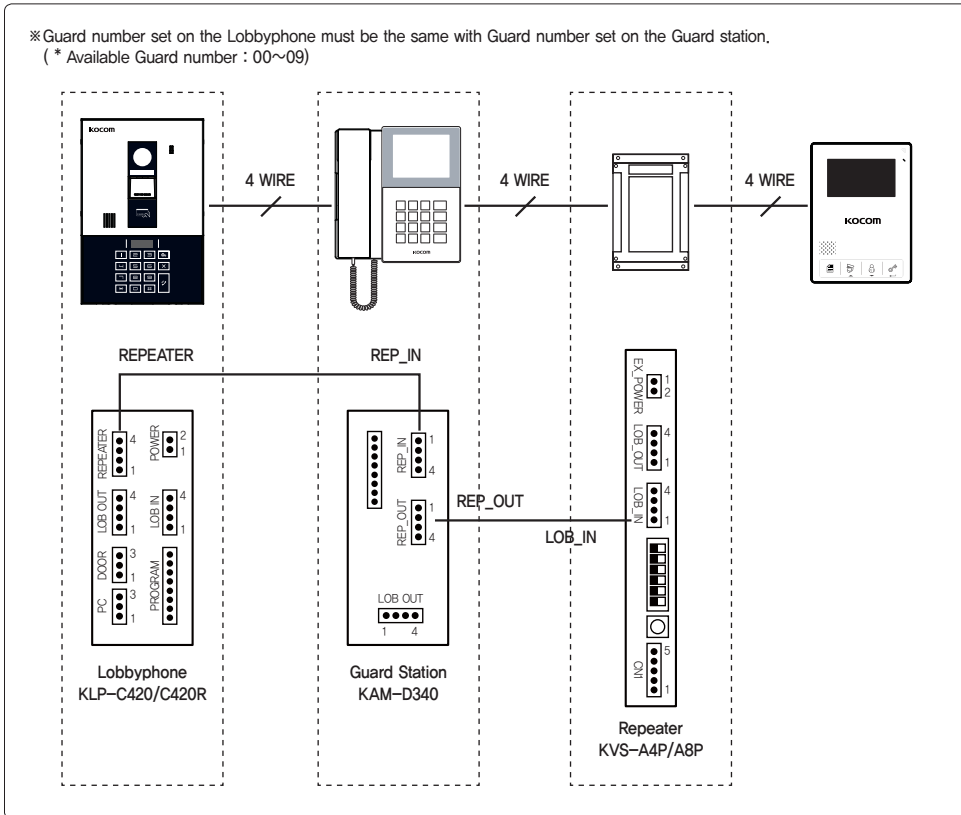

Product connection diagram

■ B type – Direct Mode

When a guard station is connected directly to the Lobbyphone(KLP-C420/C420R)

※ In case of B type, Direct Mode, only one Lobbyphone can be used.
 ※ Guard number set on the Lobbyphone must be different with Guard number set on the Guard Station.
 (* Available Guard number : 00~09)

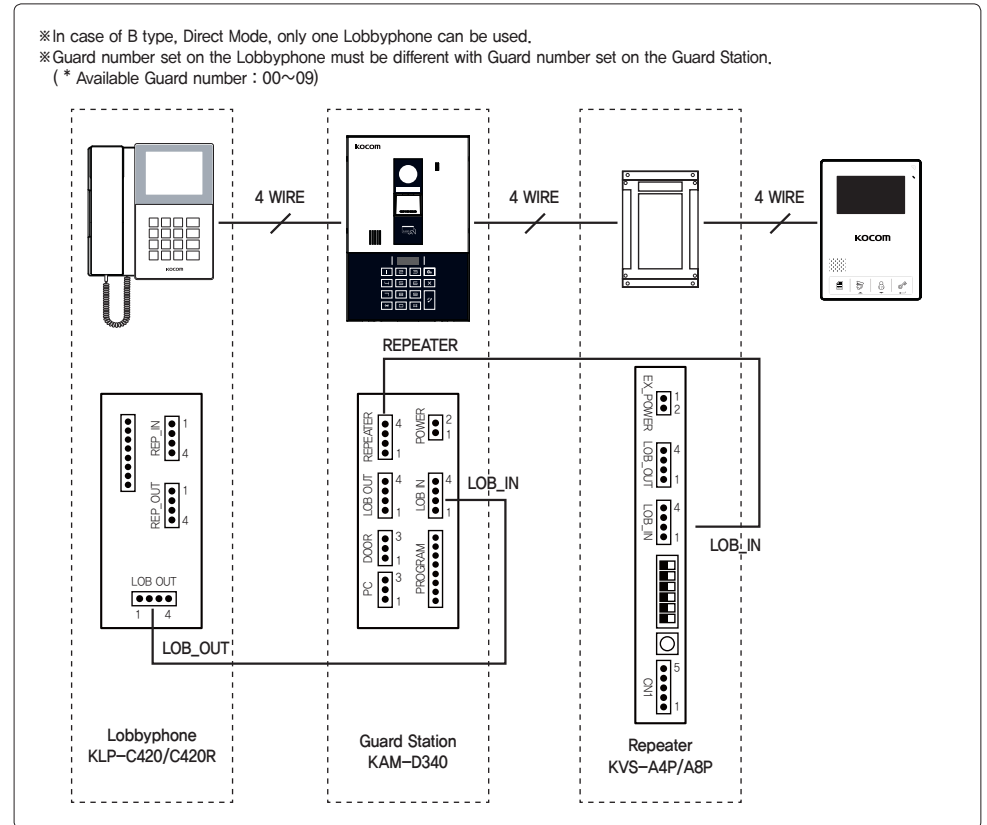

■ Name of each connection port

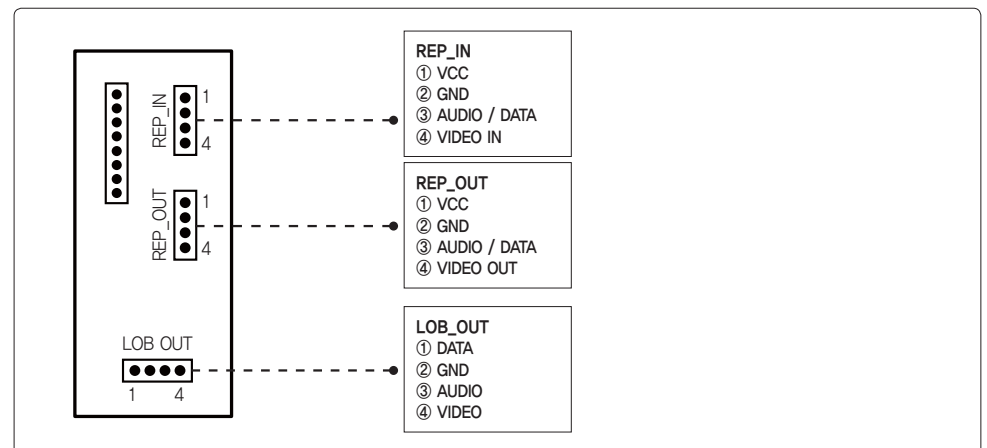

Instructions for operation

■ Booting

- ① When turning the power on, 'v0X.XX' version will be displayed on the main screen along with the booting sound.
- ② It will be automatically terminated in 2 seconds.

■ Call and communicate with a residential unit from the guard station

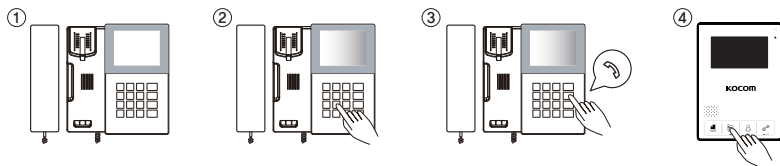

- ① Lift up the handset.
- ② Dial up the desired number of the residential unit by pressing the dial key. It can be verified through LCD screen.
- ③ By pressing [] button, a call to a residential unit will be made. (Standby time : 30 seconds)
- ④ When Call button is pressed at the residential unit with an incoming call, the call goes through. (Call & Communication time : 3 minutes)
Place the handset in the telephone base to end a call.

■ Call and communicate with a guard station from a residential unit

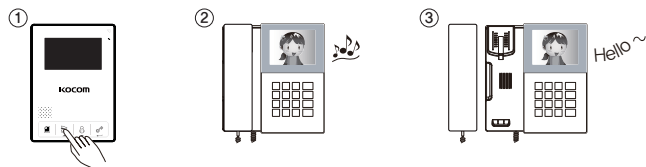

- ① By pressing [] button, a call is made to the guard station from a residential unit.
- ② With a ring tone ringing, the number of the residential unit displays at the LCD screen. (Standby time : 30 seconds)
- ③ A call goes through when lifting the handset. (Call & Communication time : 3 minutes)
When working on other features while the handset is being lifted, press [] button to make a call.
Place the handset in the telephone base to end a call.

■ Call and communicate with a guard station from the lobby phone



- ① Dial up the guard station number and press [] button. (* 2 digits must be pressed, for example, 01)
- ② With a ring tone ringing, the image of the lobby and OSD mode will be displayed at the LCD screen. (Standby time : 30 seconds)
- ③ A call goes through when lifting the handset. (Call & Communication time : 3 minutes)
When working on other features while the handset is being lifted, press [] button to make a call.
Place the handset in the telephone base to end a call.

Instructions for operation

■ LINK function between a lobby phone and residence phone

※ This feature is only functional when a guard station is installed between a lobby phone and repeater as shown as 'System configurations - A type' where '7. System Type' at the page [2] of menu configuration is set on 'Between lobby and repeater'.

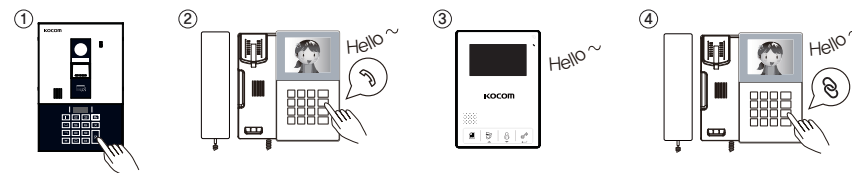

- ① When a call is made from the lobby phone to a residence, a ring tone first rings at the guard station. And the image of the lobby and the number of the residential unit are displayed at the LCD screen.
- ② Following a communication with the lobby, a call will be made from the lobby phone to the desired residential unit by pressing [] button.
- ③ Through a communication with the residence, whether to accept the call from the lobby will be determined. At this particular point in time, the image of the lobby will NOT be available at the residence phone.
- ④ When the residence wishes to accept the call from the lobby, a call will be terminated at the guard station by pressing [] button, and a call between the lobby phone and the residence will go through.

■ Door-open during a call with the lobby phone

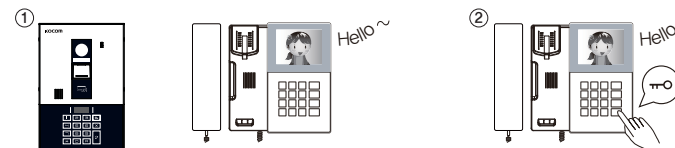

- ① A call is on with the lobby phone.
- ② Press [] button to open up the door connected with the lobby phone during a phone call.

Menu Setting

※During a standby mode, press SET button while holding the handset.

Please enter
a password !

BACK : * EXIT : #

▶ Press 4-digit password followed by "#" button.
Default password is "0000."

Page[1]
0 Save Home Number
1 Inquiry Home Number
2 All Deleted Home Number
3 Guard Number
4 Absence

BACK : * EXIT : #

Page[2]
5 Password
6 Video
7 System Type
8 Language
9 Deafault

BACK : * EXIT : #

▶ Once the password is confirmed, continue to select the features from the Page [1] and Page [2].

■ Save Home Number

Punch in the mapping number which is equivalent to the number of the residential unit.

Home Number :
Mapping Number :

BACK : * SAVE : # EXIT : SET

▶ Home Number is the number of the residential unit that is actually being in use.
Mapping Number is the number allocated to the residential unit by the repeater, KVS-A4P/A8P.

■ Inquiry Home Number

Check the mapped number of the residential unit number.

H No : M No	H No : M No
0101 : 0001	0501 : 0005
0201 : 0002	0601 : 0006
0301 : 0003	0701 : 0007
0401 : 0004	0801 : 0008

BACK : * UP : 3 DOWN : 6 EXIT : SET

▶ H No represents the Home Number whereas M No represents the Mapping Number.
0101: 0001 represents the residential unit connected to the repeater, KVS-A4P/A8P

It displays an example where the number of the repeater is 1 while the number of the residential unit connected to the repeater is 101.

■ All Delete Home Number

Delete all pre-registered Home Numbers and Mapping Numbers from the Save Home Number.

Are you sure you want
To delete all the
Home Number

YES : 1
NO : 2

BACK : * EXIT : SET

▶ When deleting the registered Home Numbers and Mapping Numbers, select "1" to delete the entire numbers

■ Guard Number

Punch in the Building Number and Guard Number.

Building Number : 0101
Guard Number : 0001

BACK : * SAVE : # EXIT : SET

▶ The example illustrates when the Building Number is "101", and the Guard Number "01".
(* Available Guard number : 00~09)

Instructions for operation

■ Absence

Activate the absence mode when no one is present at the guard station.

When installing a guard station between the lobby phone and the repeater as shown at " System configurations – A type" this feature allows to make a direct call from the lobby phone to the residential unit instead of making a call on relay mode passing through a guard station first to reach a residential unit.

Absence setting would
You like to do ?

1 : ON
2 : OFF

BACK : * EXIT : SET

▶ By selecting "1" when activating the absence mode, the absence mode is on.
Select "2" to cancel the absence mode.

Speed Key to set Absence ON or OFF pick up the handset and Press '#' button 2 secs.
(* Available only in case of Atype, Between Mode)

■ Password

It changes the password to access the menu.

Please enter
New password !

[]

BACK : * SAVE : # EXIT : SET

▶ A password for the menu will be changed by punching in 4-digit number to [].

■ Video

It changes the configuration related to the video feature.

Video Setting

1] HUE []
2] BRIGHT [5]
3] NTSC/PAL AUTO

BACK : * UP : 6 DOWN : 9 EXIT : SET

▶ HUE : It configures the LCD color between 0 and 255.

BRIGHT : It sets up the brightness of LCD between 1 and 10.

NTSC/PAL : It will be automatically configured when setting up AUTO and detecting the first video footage. NTSC and PAL will be configured for the exclusive use.

■ Save Home Number

The location to install the guard station will be configured.

Please choose
a guard location

1. Between Lobby
and repeater
2. Connected directly
to lobby

BACK : * EXIT : SET

▶ (System Configuration-A Type) The guard station will be placed between the lobby phone and the connection terminal of the repeater.
Connected directly to lobby(System Configuration-B Type) It is to be connected to the terminal of the lobby phone (LOB_IN).

■ Language

Select the language which you wish to use.

Please Choose
a language

1. English
2. Spanish

BACK : * EXIT : SET

▶ It is select English or Spanish for the language to use.

■ Default

All configuration values will return to the default state.

Are you sure you want
to factory reset?

1. Yes
2. No

BACK : * EXIT : SET

▶ By selecting YES at the Default, the initialization process will proceed as follows.

- Home Number : All delete
- Guard Number : Building Number (0001), Guard Number (0001)
- Absence : OFF
- Password : 0000
- Video : HUE(0), BRIGHT(5), NTSC/PAL(AUTO)
- System Type : Between lobby and repeater
- Language : English